

2.- Transporte de Ganado

SUELO GANADERO 260			
PTM-009	4,22 Kg/ml	6106 T6	
	1557 mm ²	1305 mm	
SUELO GANADERO 175			
PTM-010	2,24 Kg/ml	6106 T6	
	825 mm ²	911 mm	
BARROTE 40 x 20			
PTM-013	0,69 Kg/ml	6005 T6	
	253 mm ²	182 mm	
VIGUETA 6 mm			
PTM-029	2,92 Kg/ml	6005 T6	
	1078 mm ²	356 mm	
PILAR 155 x 39 x 3,5			
PTM-030	3,39 Kg/ml	6005 T6	
	1252 mm ²	642mm	
TUBO RECT. 80 x 120 x 6			
PT-0005	6,15 Kg/ml	6082 T6	
	2270 mm ²	738 mm	
TUBO Ø50 x Ø40			
PT-0016	1,91 Kg/ml	6005 T6	
	707 mm ²	283 mm	
ANGULO 40 x 40 x 3			
PT-0018	0,62 Kg/ml	6005 T6	
	231 mm ²	159 mm	
TUBO RECT. 80 x 40 x 4			
PT-0067	2,42 Kg/ml	6005 T6	
	875 mm ²	437 mm	

PERFILES

TRANSPORTE DE GANADO

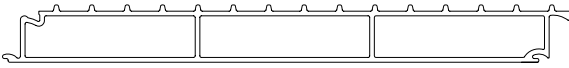
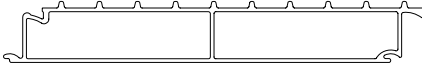
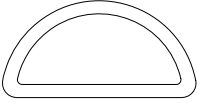
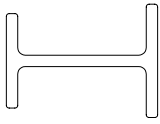
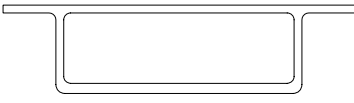
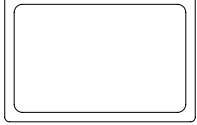
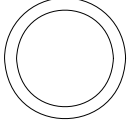
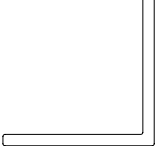
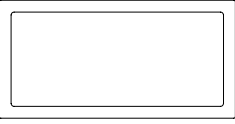
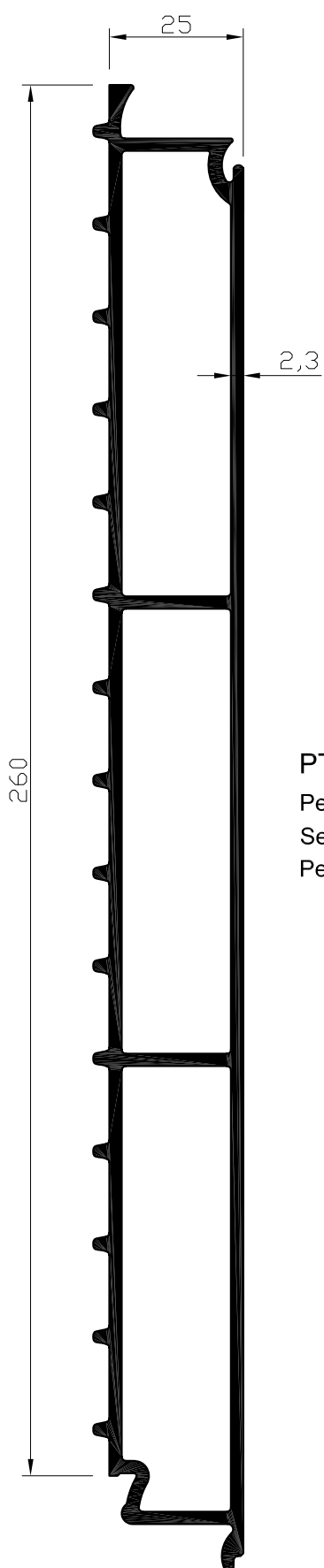

PTM-009

Peso : 4,22 Kg/m

Sección : 1557 mm

Perímetro : 1305 mm

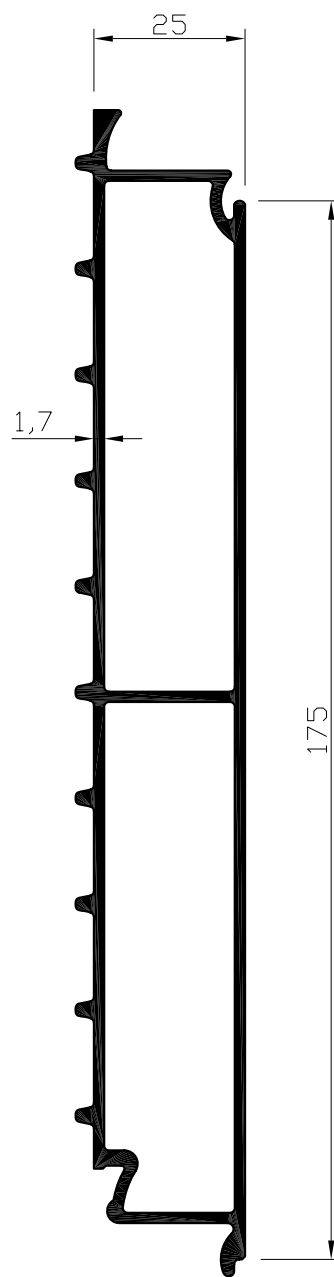

PTM-010

Peso : 2,24 Kg/m

Sección : 825 mm

Perímetro : 911 mm

PERFILES

TRANSPORTE DE GANADO

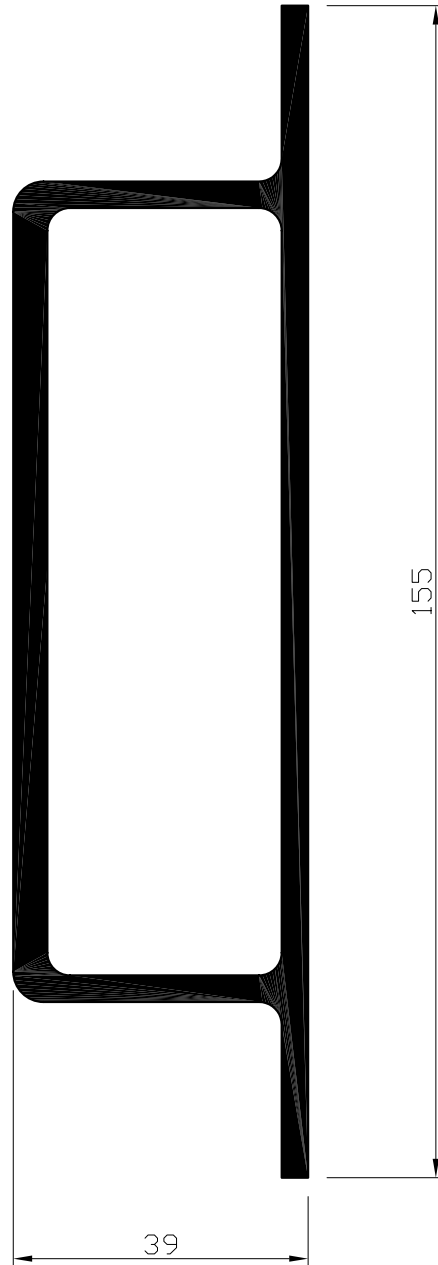

PTM-030

Peso : 3,39 Kg/m

Sección : 1252 mm

Perímetro : 642 mm

PERFILES

TRANSPORTE DE GANADO

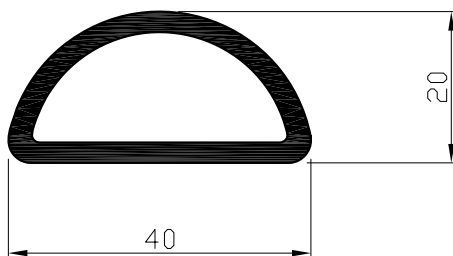

PTM-013

Peso : 0,69 Kg/m

Sección : 253 mm

Perímetro : 182 mm

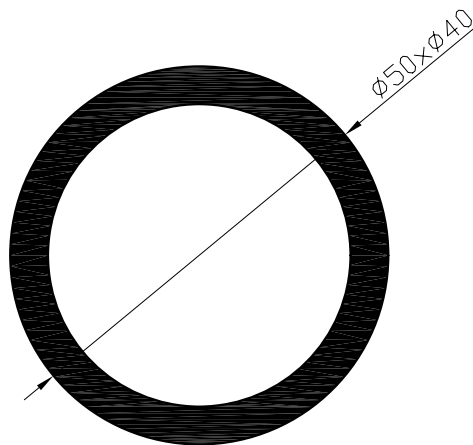

PT-0016

Peso : 1,91 Kg/m

Sección : 707 mm

Perímetro : 283 mm

PERFILES

TRANSPORTE DE GANADO

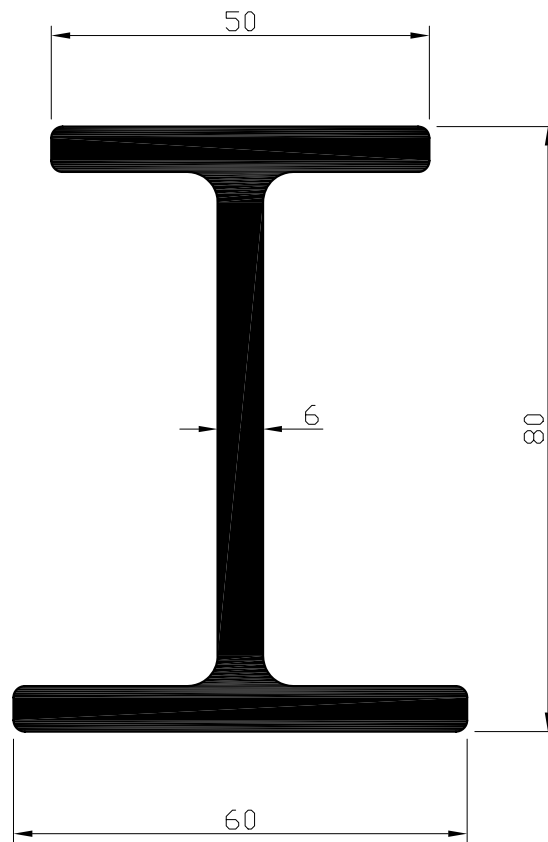

PTM-029

Peso : 2,92 Kg/m

Sección : 1078 mm

Perímetro : 356 mm

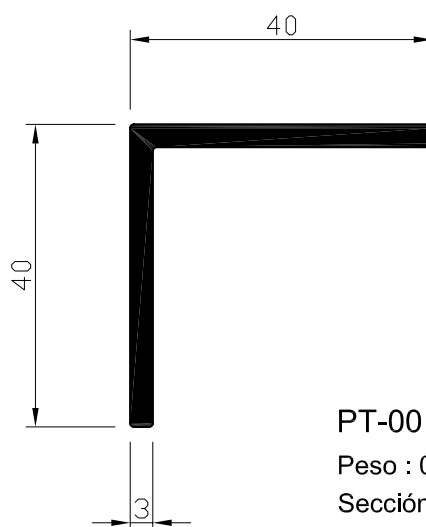

PT-0018

Peso : 0,62 Kg/m

Sección : 231 mm

Perímetro : 159 mm

PERFILES

TRANSPORTE DE GANADO

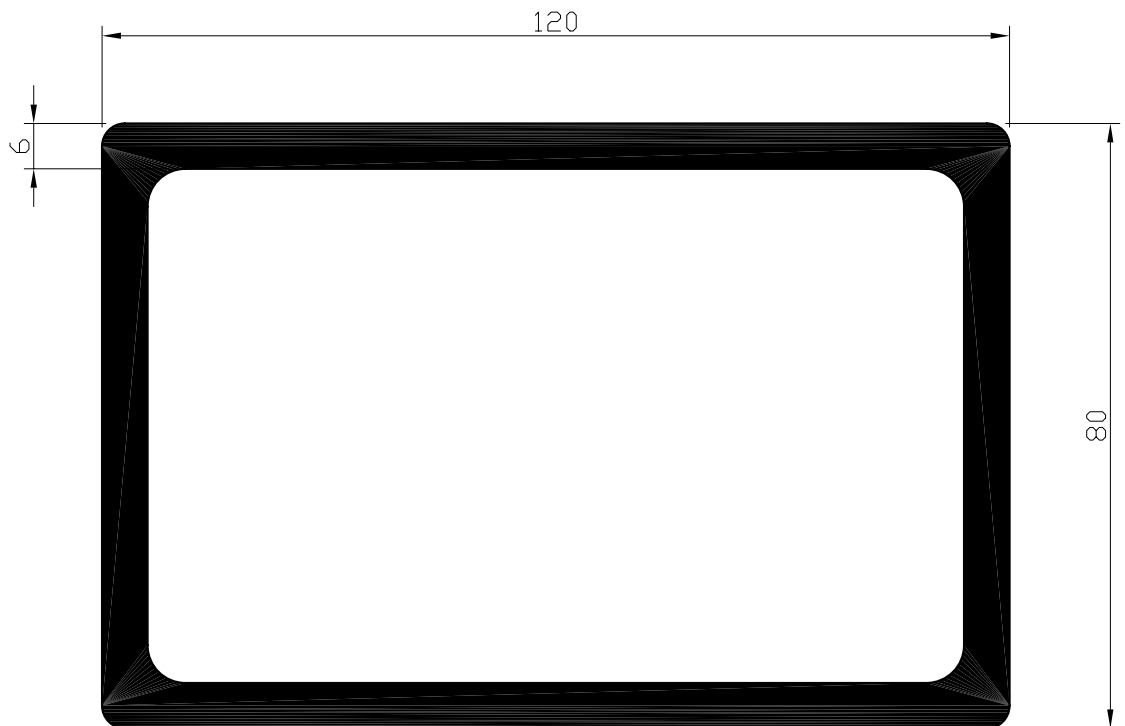

PT-0005

Peso : 6,15 Kg/m

Sección : 2270 mm

Perímetro : 738 mm

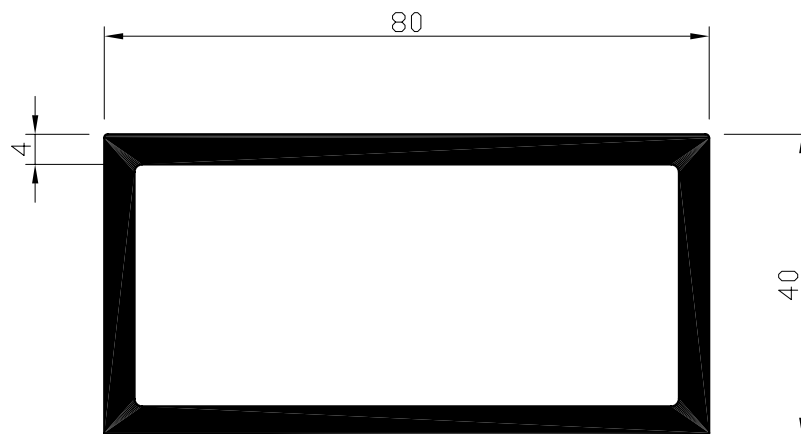

PT-0067

Peso : 2,42 Kg/m

Sección : 875 mm

Perímetro : 437 mm